



Agilent 8594Q QAM Analyzer

DVB-C Solutions

Product Overview

The first choice for field testing of DVB-C signals on your cable TV system

All cable TV network operators planning the introduction of DVB-C (Digital Video Broadcast via Cable) services have increasing competitive pressure to install these new services—quickly. Aggressive activation schedules require test equipment capable of verifying your quality of service—fast. The Agilent Technologies 8594Q QAM¹ analyzer is a comprehensive and powerful test solution for installation and maintenance test on European DVB-C systems. Supporting 8, 4, and 2 MHz channel bandwidths,² the 8594Q QAM analyzer makes both qualitative and quantitative measurements on the transmitted QAM signal. It gives engineers the measurement capability required to accurately verify the quality of service delivered to subscribers. All measurements are presented in a user friendly manner so the engineer can focus on the job at hand, not on operating the test equipment.



The 8594Q QAM analyzer can help you during:

- Headend equipment installation and maintenance
- System verification
- Field installation and maintenance
- Modulator manufacturing test

The 8594Q QAM analyzer demodulates and accurately measures the QAM signals carried through the DVB-C system. It provides new measurement metrics necessary to characterize these signals and troubleshoot problems. The 8594Q QAM analyzer's clear user interface and one-button measurement capability will make the transition from analog to digital testing easy for cable TV engineers.

1. QAM—Quadrature Amplitude Modulation. The 8594Q QAM analyzer supports 16, 64, and 256 state QAM.
2. Option J91 provides RF and modulation analysis on QAM systems using 6 MHz channel bandwidths and using alternate coding standards.



Agilent Technologies

Innovating the HP Way

Verify your quality of service

Activate your DVB-C services faster

To help you activate your DVB-C services faster, test equipment must provide a comprehensive suite of measurements. The ability to analyze the signals on the system in detail will help you to quickly identify and troubleshoot problems. With the new challenge of testing digital signals it is important that your test equipment is easy to use. With the 8594Q QAM analyzer's one button measurement capability, engineers will be able to concentrate on getting measurement results, not finding the right menu. The portable, rugged 8594Q QAM analyzer is ideal for testing from the headend through the network to the subscriber drop.

This combination of powerful measurements and usability will ease your transition from analog to DVB-C testing.

Digital video measurement overview

The shift from analog to digital technology brings many new measurement challenges. Analog system measurements which would have indicated a high quality of service are no longer appropriate. Where analog signals degrade slowly as impairments become worse, digital signals will provide excellent picture quality then degrade very rapidly upon reaching the threshold. Analyzing these digital signals in detail is crucial to determining the real quality of service being delivered to your customer.

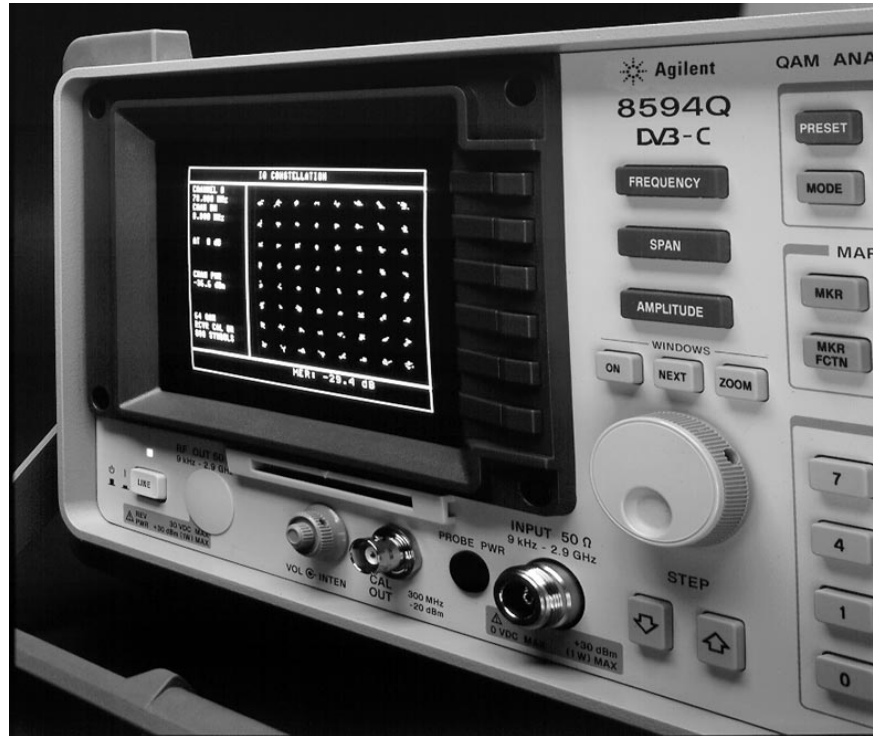

Comprehensive RF and modulation

Comprehensive measurement capability

To accurately verify your quality of service the following measurements are important:

Average channel power

Channel power is the most basic measurement of digital signals on your DVB-C system. The 8594Q QAM analyzer gives a real-time display of the average power across the channel being measured. The sensitivity of the EM 8594Q QAM analyzer allows measurements throughout the system, from the headend to the low level signals at the subscriber drop.

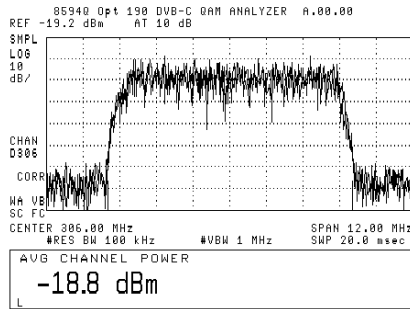

Average channel power measured on an Agilent 8594 QAM analyzer

Adjacent channel power

Adjacent channel power provides a measure of how much a transmission is leaking, into the immediately adjacent channels. Measurements are carried out across the transmission channel as well as two adjacent channels. The power level is presented for each channel.

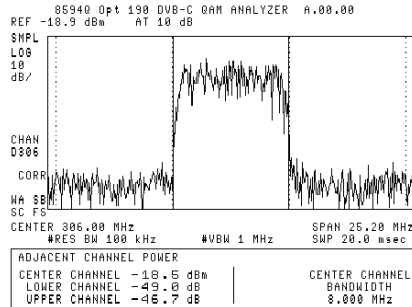

Adjacent channel power measured on an Agilent 8594 QAM analyzer

Constellation display

The constellation display gives a graphical view of the demodulated QAM signal. This allows quick identification of impairments such as gain compression or IQ imbalance. The information from the visual appearance of the constellation display can be used to isolate and troubleshoot problems.

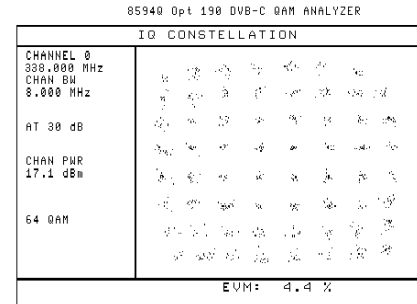

The Agilent 8594Q QAM analyzer constellation display of a signal with gain compression

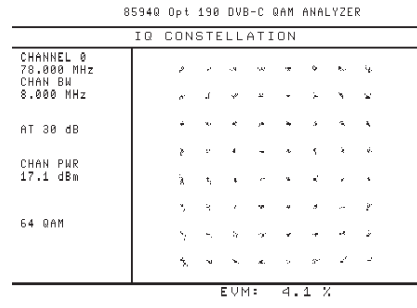

The Agilent 8594Q QAM analyzer constellation display of a signal with IQ imbalance

MER (modulation error ratio) and EVM (error vector magnitude and origin offset)

MER and EVM give a metric measurement of the modulation quality. The measurement results can be displayed in real-time alongside the graphical constellation. Alternatively, ten average, maximum, minimum and standard deviation measurements can be captured and analyzed for trends.

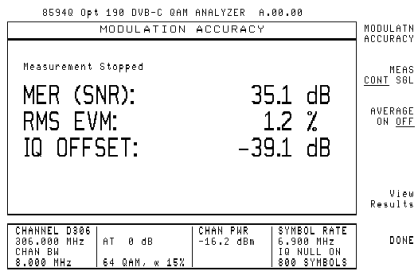

The Agilent 8594Q QAM analyzer display of MER, EVM, and IQ offset

Built-in equalizer response

The built-in adaptive equalizer in the 8594Q QAM analyzer displays both impulse and frequency response. The impulse response allows identification of micro-reflections in the transmission plant while the frequency response shows any tilt across the channel.

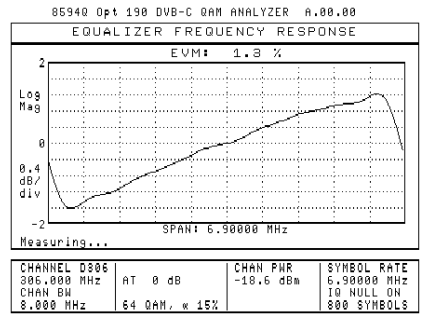

The Agilent 8594Q QAM analyzer display of the built-in equalizer frequency response

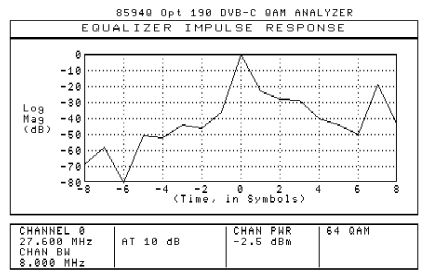

The Agilent 8594Q QAM analyzer display of the built-in equalizer impulse response

Estimated SER (symbol error ratio) versus carrier to noise

The estimated SER versus carrier-to-noise ratio measurement shows the current operating point of the cable TV system. A calculation is carried out for each measured constellation point to determine its probability of being misinterpreted. This point is then plotted against the current carrier-to-noise ratio. An operating curve can then be traced out by adding an external noise source to decrease the carrier-to-noise ratio.

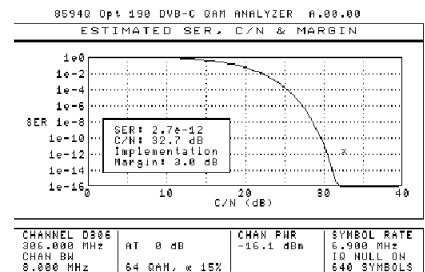

The Agilent 8594Q QAM analyzer display of SER versus carrier to noise

Spectrum analysis

In addition to these specific DVB-C measurements, the 8594Q QAM analyzer provides a fully featured 2.9 GHz spectrum analyzer.

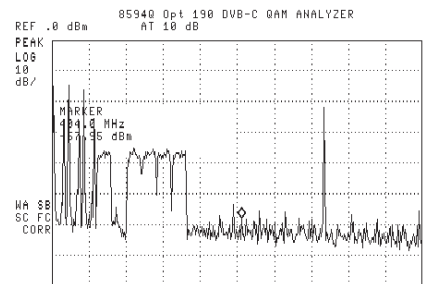

The Agilent 8594Q QAM analyzer showing a sweep of several analog and digital channels

Data analysis option

Check data integrity

Add Option 195¹ to the 8594Q QAM analyzer to verify that the MPEG data has been correctly decoded, and check transport stream content. The option also proves a real-time output (both ASI and parallel), to allow access to the data stream for further comprehensive analysis.

Reed-Solomon error

Examining the statistics from the forward error correction (FEC) system gives information about the transmission margin of the RF channel. The FEC process adds information to each packet in the transport stream, to enable the correction of transmission errors. The 8594Q Option 195 includes a real-time FEC decoder. By monitoring the activity of the FEC decoder, analysis of byte and packet errors is provided. Since this analysis can be made on live data, this is the method recommended for non-intrusive in-service bit error ratio estimation.

REED-SOLOMON RESULTS	
<u>Byte Errors</u>	
Count	186924
Ratio	4.338E-04
<u>Packet Errors</u>	
Count	72
Ratio	3.408E-05
CHANNEL USER	TIME: 00d 00h 01m 23s
723.125 MHz	RESULTS: [Cumulative]
41.25 Mb/s	
Measurement Stopped	

Reed-Solomon byte and packet error count displayed on an Agilent 8594Q Option 195 QAM analyzer

PID statistics

The program identifier (PID) statistics provide two critical pieces of information about the MPEG transport stream. First, they list the individual data streams which make up the transport stream, along with the data rate associated with each one. An operator can check the video, audio and data content of the stream, and check for “illegal” PIDs. The number of “null” packets (added to bring the overall data rate up to the rate used for the channel) determines how much more information could be added to the stream. Second, they allow identification of any PID which has suffered uncorrectable packet errors during transmission. Packet errors cause glitches or blocking effects on the picture.

188.20305 PID STATISTICS			
	PID	TEI	Net Kb/s
10	02D0	00001	4056
9	0212	00000	136
8	0140	00002	4052
7	00DC	00000	4056
6	0078	00002	4050
5	0398	00001	4056
4	026C	00001	4056
3	0208	00001	4074
2	0104	00002	6159
1	0032	00000	52
NULL Packet Min. Rate: 1446 Kb/s			Total: 30015
NULL Packet Max. Rate: 2197 Kb/s			Averages: Off
NULL Packet Mean Rate: 1976 Kb/s			
CHANNEL USER	TIME:	00d 00h 02m 57s	
723.125 MHz	RESULTS:	Real Time	
41.25 Mb/s			
Measuring...			

The PID statistics of a transport stream displayed on an Agilent 8594Q Option 195 QAM analyzer

Bit error ratio testing

For out-of-service testing of a digital channel, the recommended quality metric is bit error ratio (BER). Typical headend modulators can be set to transmit a standard continuous 2²³-1 pseudo-random binary sequence (PRBS). The 8594Q QAM analyzer data analysis option allows the instrument to function as a BER receiver, providing analysis and display of true bit error ratio measurements during installation of new channels or during system troubleshooting.

CONTINUOUS PRBS RESULTS	
<u>Bit Errors</u>	
Count	14
Ratio	1.765E-08
CHANNEL 0338	TIME: 00d 00h 00m 19s
888.000 MHz	RESULTS: [Cumulative]
41.40 Mb/s	
Measuring...	

The Agilent 8594Q Option 195 QAM analyzer makes the key out-of-service test of bit error ratio

1. Option 195 measurements are specific to the European DVB standard. The option is not compatible with other digital video standards.

Solutions from baseband to RF

Digital Video Test Solutions

Agilent provides a comprehensive range of test equipment for DVB-C analysis, generation and MPEG analysis.

RF Testing

Agilent 8594Q DVB-C QAM Analyzer



- Field testing solution for the European DVB-C standard
- Comprehensive RF and data quality testing
- Test from the headend to the subscriber drop

Agilent 8591C Cable TV Analyzer



- Includes digital carrier power measurement
- In service analog RF and video measurements

Agilent 89441A Option AYH Digital Video Modulation Analysis



- Provides highest quality QAM and VSB analysis capabilities
- Measures key modulation metrics
- Ideal for R&D use

Agilent CaLan 3010R/H Sweep/Ingress Analyzer



- Return sweep and ingress detection
- Includes digital carrier power measurements
- Identify, troubleshoot, and eliminate ingress

Agilent E4441A DVB QAM Coder



- Fully compliant with DVB-C specifications
- Flexible real-time encoding
- Built-in calibrated impairments simplifies receiver characterization

MPEG Testing

Agilent E6277A MPEGScope Plus



- Verify or troubleshoot MPEG-2/DVB/ATSC implementations
- Generate and capture MPEG-2 streams up to 60Mb/s
- Live monitoring and analysis of MPEG-2 transport streams
- Complete MPEG-2, DVB and ATSC protocol decode

Agilent E6271A MPEGScope ATM Test Application

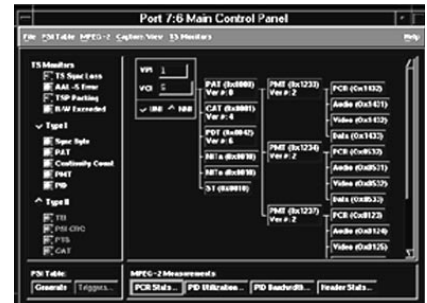

- Comprehensive MPEG-2 testing for the Agilent E4200B/4210B Broadband Series Test System—the ATM industry standard tester
- Real-time MPEG-2 transport stream analysis for ATM systems
- Implements key measurements including PCR jitter
- Supports most ATM standard interfaces from DS1 to OC-3DVB-C channel bandwidths

Agilent 8594Q QAM Analyzer Specifications

This section contains specifications and characteristics for the 8594Q QAM Analyzer. The distinction between specifications and characteristics is described as follows.

Specifications describe warranted performance over the temperature range 0 °C to +55 °C (unless otherwise noted). The analyzer will meet its specifications under the following conditions: 0 °C to +50 °C with Option 015 or Option 016 operating/carrying case; the instrument is within the one year calibration cycle; two hours of storage at a

constant temperature within the operating temperature range; thirty minutes after the analyzer is turned on; after the CAL frequency, and CAL amplitude routines have been run.

Characteristics provide useful, but non-warranted information about the functions and performance of the analyzer. Characteristics are specifically identified. Typical performance, where listed, is not warranted, but indicates performance that most units will exhibit. Nominal value indicates the expected, but not warranted, value of the parameter.

Spectrum Analyzer Specifications

When used as a spectrum analyzer, the 8594Q QAM analyzer conforms to all specifications described in *Agilent 8590E-Series Portable Spectrum Analyzers*, Data Sheet, literature number 5963-6909E.

Specifications for DVB measurement capability

DVB-C channel bandwidths	8 MHz, 4 MHz, and 2 MHz		
Supported symbol rates (Characteristics) (also see Option J91)			
Channel Bandwidth	8 MHz	4 MHz	2 MHz
Symbol Rate	6.9 MSymbol/s 6.89 MSymbol/s 6.875 MSymbol/s 6.872 MSymbol/s	3.45 MSymbol/s 3.445 MSymbol/s 3.4375 MSymbol/s 3.436 MSymbol/s	1.725 MSymbol/s 1.72 MSymbol/s 1.71875 MSymbol/s 1.718 MSymbol/s
Channel selection standard tuning ranges	DVB-C D channel 31–41, 330–445 CCIR VHF S channels 21–41 CCIR UHF U channels 21–69		
User defined channel tuning	10 MHz to 2.9 GHz 10 MHz to 1 GHz (with internal pre-amplifier)		
Testing at the headend			
Conditions	Single input signal		
Average power measurement			
Minimum average power at input without preamp	8 MHz –60 dBm –62 dBm typical	4 MHz –63 dBm –65 dBm typical	2 MHz –66 dBm –68 dBm typical
with preamp ¹	–81 dBm –83 dBm typical	–84 dBm –87 dBm typical	–87 dBm –90 dBm typical
Average power accuracy	± 2.8 dB, ± 1 dB typical		
Residual EVM/MER	EVM 1.47 % 1.16 % typical	MER 33 dB 35 dB typical	
Reflects mean residual EVM/MER of 50 individual measurements All measurements using 800 symbols Typical value is at 20 °C to 30 °C (room) temperature			
Minimum power input for EVM/MER measurements	–55 dBm (Using internal pre-amplifier)		

1. Gain error of internal pre-amp not included

Agilent 85940 QAM Analyzer Specifications

Testing at the subscriber drop

Conditions

Multiple input signals
Total incident power at 50 ohm <+17 dBm¹
Without external pad

Average power measurement

Minimum average power at input without preamp	8 MHz	4 MHz	2 MHz
	-40 dBm	-43 dBm	-46 dBm
	-42 dBm typical	-45 dBm typical	-48 dBm typical
with preamp ²	-41 dBm	-44 dBm	-47 dBm
	-43 dBm typical	-47 dBm typical	-50 dBm typical

Average power accuracy

± 2.8 dB, ± 1 dB typical

Residual EVM/MER

(For total incident power at input <+20 dBm)

EVM

2.07 %
1.74 % dB typical

MER

30 dB
31.5 dB typical

Reflects mean residual EVM/MER of 50 individual measurements
All measurements using 800 symbols
Typical value is at 20 °C to 30 °C (room) temperature

Minimum power input for EVM/MER measurements

-55 dBm (Using internal pre-amplifier)

Characteristics

Demodulator characteristics

Supported digital demodulation format 16, 64, 256 Quadrature Amplitude Modulation
Nyquist Filter Alpha 0.15 time DFE/FFE Adaptive Equalizer

ACP dynamic range

58 dB without internal pre-amplifier

Maximum total incident input power

+ 30 dBm without internal pre-amplifier
+ 5 dBm with internal pre-amplifier

Pre-amp typical specifications

Maximum safe input level	-5 dBm (average or peak power)
Gain	+23 dB ± 3 dB
Frequency range	1 MHz to 1 GHz
Flatness	±0.5 dB
Noise figure	4 dB maximum
TOI	+14 dBm

1. Improved performance may be possible by pre-filtering the analyzer input using a tunable Bandpass filter with approximately 10 MHz 3 dB bandwidth.
2. Gain error of internal pre-amp not included

Front and rear panel interfaces

Front Panel

RF Input	50 ohms Type-N
Calibration Output	50 ohms BNC, -20 dBm, 300 MHz
Probe Power	+15Vdc, -12.6 Vdc, and Gnd 150 mA each

Rear Panel

Keyboard (Standard or Option 043)	5-Pin mini-DIN, compatible with C1405B and most IBM/AT keyboards
External Trigger Input	BNC, TTL levels, positive edge trigger
GPIO and Parallel	SH1, AH1, T6, L4, ST1, RL1, PPO, DC1, C1 C2, C3, & C28 and 25 Pin subminiature D-shell female or parallel
RS-232 and Parallel (Option 043)	9-Pin subminiature D-shell female and 25 Pin subminiature D-shell female for parallel
External Ref Input	50 ohms BNC, 10 MHz, -2 to +10 dBm
10 MHz Ref Output	50 ohms BNC, 10 MHz, 0 dBm
Monitor Out	50 ohms BNC, Selectable format NTSC, 15.75 kHz, 60 Hz PAL, 15.625 kHz, 50 Hz

DVB Parallel interface (Option 195)

25-Pin subminiature D-shell female. Compliant with DVB-PI specification, 188 or 204 byte mode user-selectable

DVB ASI serial interface (Option 195)

75 ohms BNC. Compliant with DVB-ASI specification, 188 or 204-byte mode, user-selectable

Data measurements (Option 195)

(Option 195 measurements are specific to the European DVB standard. The option is not compatible with other digital video standards)

PID statistics measurement

Maximum number of PID's analyzed simultaneously	64
Transport stream net data rate accuracy	1% without averaging
PID net data rate accuracy	1% without averaging
Transport stream gross data rate accuracy	1% without averaging

Multiplex overview measurement

Maximum number of PIDs detected in transport stream	5000
Maximum number of PIDs analyzed simultaneously	10
Transport stream net data rate accuracy	1% without averaging
PID net data rate accuracy	1% without averaging
Transport stream gross data rate accuracy	1% without averaging

Reed-Solomon error statistics measurement

Measurement displays	Byte error count
	Byte error ratio
	Packet error count
	Packet error ratio
	Estimated bit error ratio

Bit error ratio measurement

Measurement stimulus types	$2^{23} - 1$ continuous PRBS
	Sync (47hex, no inversion) + 203-byte $2^{23} - 1$ PRBS*
	R-S encoded packet with payload of 187 bytes of $2^{23} - 1$ PRBS*
	R-S encoded packet with user-definable PID and payload of 184 bytes of $2^{23} - 1$ PRBS*
	R-S encoded packet with null PID value and payload of 184 bytes of 0000
	*Note: PRBS sequence paused during header and Reed-Solomon bytes

Agilent 85940 QAM Analyzer Specifications

6 MHz channel operation (Option J91)

Characteristics

Channel bandwidth	6 MHz
Supported symbol rates	5.056941, 5.360537, 5.274 Msymbols/s
Nyquist Filter Alpha	0.12 to 0.18 DFE/FFE, automatically selected by symbol rate

Channel selection

Standard tuning ranges	Standard, HRC, IRC, Air channel plans of EIA Interim Standard IS-6
-------------------------------	---

User-defined channel tuning

10 MHz to 2.9 GHz
10 MHz to 1 GHz (with internal pre-amplifier)

Dimensions

Without handle, feet, or cover	163 mm (H) x 325 mm (W) x 427 mm (D)
Overall	184 mm (H) x 373 mm (W) X 461 mm (D)
Weight	
Net	16.4 kg (36 lb)
Shipping	19.1 kg (42 lb)

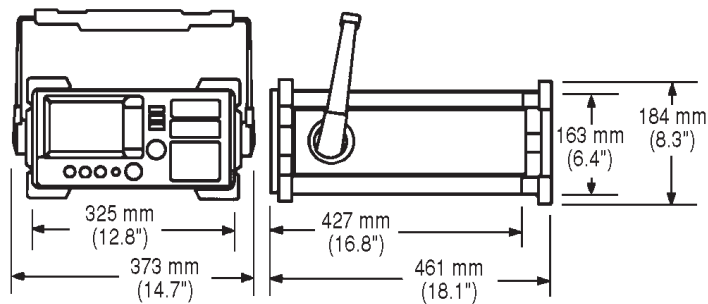

General Specification

Temperature range	Operating 0 °C to +55 °C Storage -40 °C to +75 °C
EMI compatibility	Conducted and radiated interference CISPR Pub. 11 and Messempefaenger Postverfuegung 526/527/79
Audible noise	<37.5 dBa pressure and <5.0 Bels power (ISODP7779)
Power requirements	
ON (Line 1)	90 to 132 V rms, 47 to 440 Hz, 195 to 250 V rms, 47 to 66 Hz Power consumption <500 VA; <180W
Standby (Line 0)	Power consumption <7 W
User program memory	289 Kbytes non-volatile RAM
Data storage (nominal)	Internal 24 traces or 32 states

Ordering Information

8594Q QAM Analyzer

Option 190¹	DVB-C RF and modulation quality measurements (includes DVB-C measurement software, precision frequency reference, GPIB/parallel interface)
Option J91²	6 MHz channel operation (includes RF and modulation quality measurement software, precision frequency reference, GPIB/parallel interface)
Option 195³	Data measurements
Option 016	Soft yellow operating/carrying case
Option 040	Front panel protective cover w/storage
Option 042	Protective soft carrying case
Option 043	Replace GPIB/parallel interface with RS232/parallel interface
Option 908	Rack mount kit without handles
Option 909	Rack mount with handles
Option 910	Additional manual set

Related test equipment

E4441A DVB QAM Coder

E443xA Series digital signal generators

89441A 2.65 GHz vector signal analyzer

Option AYA	Vector modulation analysis
Option AYH	Digital video modulation analysis
Option UFG	4 Mbytes extended RAM and additional I/O

8591C Cable TV Analyzer, 1.8 GHz, 75-ohm input

(includes digital carrier power measurement)

CaLan 3010R/H Sweep/Ingress Analyzer

(includes digital carrier power measurement)

E6277A MPEGScope DVB Plus

Recommended Agilent accessories

85702A 128K RAM card

85704A 256K RAM card

85705A 512K RAM card

85901A Portable AC power source

24542U RS-232 9-pin cable (analyzer to PC)

24542G RS-232 9-pin to 25-pin cable (analyzer to PC)

C2950A Parallel 36-pin to 25-pin cable (analyzer to printer)

10833A GP-IB cable (1 m)

For further information on the 8594Q QAM analyzer the following literature may be ordered:

Agilent 8594Q QAM Analyzer; photo card 5965-3210E
Agilent 8594Q QAM Analyzer; product note 5965-4991E

Visit the interactive demo page on the World Wide Web at www.agilent.com/info/agilent8594Q_demo

For further information on associated test equipment the following literature may be ordered:

Agilent E4441A DVB QAM Coder; product information 5965-4722E
Agilent Calan 8591C Cable TV Analyzer 5964-0244E
Agilent CaLan 3010R/H Sweep/Ingress Analyzer 5965-1108E
Agilent 89440A Option AYH Vector Signal Analyzer,
product information 5964-3403E
MPEGScope DVB Plus; product information 5965-8194E

Agilent Technologies' Test and Measurement Support, Services, and Assistance

Agilent Technologies aims to maximize the value you receive, while minimizing your risk and problems. We strive to ensure that you get the test and measurement capabilities you paid for and obtain the support you need. Our extensive support resources and services can help you choose the right Agilent products for your applications and apply them successfully. Every instrument and system we sell has a global warranty. Support is available for at least five years beyond the production life of the product. Two concepts underlie Agilent's overall support policy: "Our Promise" and "Your Advantage."

Our Promise

"Our Promise" means your Agilent test and measurement equipment will meet its advertised performance and functionality. When you are choosing new equipment, we will help you with product information, including realistic performance specifications and practical recommendations from experienced test engineers. When you use Agilent equipment, we can verify that it works properly, help with product operation, and provide basic measurement assistance for the use of specified capabilities, at no extra cost upon request. Many self-help tools are available.

Your Advantage

"Your Advantage" means that Agilent offers a wide range of additional expert test and measurement services, which you can purchase according to your unique technical and business needs. Solve problems efficiently and gain a competitive edge by contracting with us for calibration, extra-cost upgrades, out-of-warranty repairs, and on-site education and training, as well as design, system integration, project management, and other professional services. Experienced Agilent engineers and technicians worldwide can help you maximize your productivity, optimize the return on investment of your Agilent instruments and systems, and obtain dependable measurement accuracy for the life of those products.

Get assistance with all your test and measurement needs at:
www.agilent.com/find/assist

Product specifications and descriptions in this document subject to change without notice.

Copyright © 1998, 2000 Agilent Technologies
Printed in U.S.A. 6/00
5965-5826E



Agilent Technologies

Innovating the HP Way